The logo features a blue circular icon with a white center and a black arrow pointing clockwise, positioned to the left of a vertical black line. To the right of the line, the letters 'UEK' are written in a bold, black, sans-serif font. Below this, the word 'Automation' is written in a bold, blue, sans-serif font. The background is a light blue gradient with a network of glowing nodes and lines.

UEK
Automation

HAKKIMIZDA

UEK Mühendislik yurtiçi ve yurtdışında çeşitli sektörlerde makine ve endüstriyel tesis otomasyonu çözümleriyle alakalı uluslararası standartlara uygun mühendislik, yazılım, elektrik pano imalatı, saha montajı, servis ve ürün tedariki konularında hizmet vermektedir.

Amacımız müşterilerimizin taleplerini ve sunulacak diğer tüm hizmetleri optimum sürelerde, noksansız ve günün teknolojisine uygun ürün ve çözümlerle gerçekleştirip devamlılığı ve verimliliği sağlamaktır.

Kadromuzdaki teknik uzmanlarımız bu çözümleri siz müşterilerimizin beklentilerine yönelik bakış ve çalışmalarınıyla memnuniyetinizi sağlarken etik ve ahlaki değerler çerçevesinde hareket etmeyi ilke edinmişlerdir.

İLETİŞİM

Mail: uek@uekmuhendislik.com

Adres: Fatih Mahallesi, 1167 Sokak, B-Fab Sitesi, E Blok, No: 7, Sarnıç - Gaziemir / İZMİR

Telefon: 0537 441 26 41

HİZMETLER

Otomasyon ve Elektrik Tasarım, Planlama,
Projelendirme ve Mühendislik Hizmetleri

Otomasyon, Elektrik Malzeme Tedarik Hizmetleri

Otomasyon ve Elektrik Pano İmalatı

Saha Kurulumu

Bina Otomasyon Yazılımları

Makine Modernizasyonu

Program Bakım ve Güncelleme Hizmetleri

Otomasyon Yazılımı

Plc Yazılım Hizmetleri

Hmı ve Scada Yazılım Hizmetleri

Cnc ve Motion Kontrol Yazılım Hizmetleri

Özel Bilgisayar Programlama Hizmetleri

Veri İşleme ve Raporlama

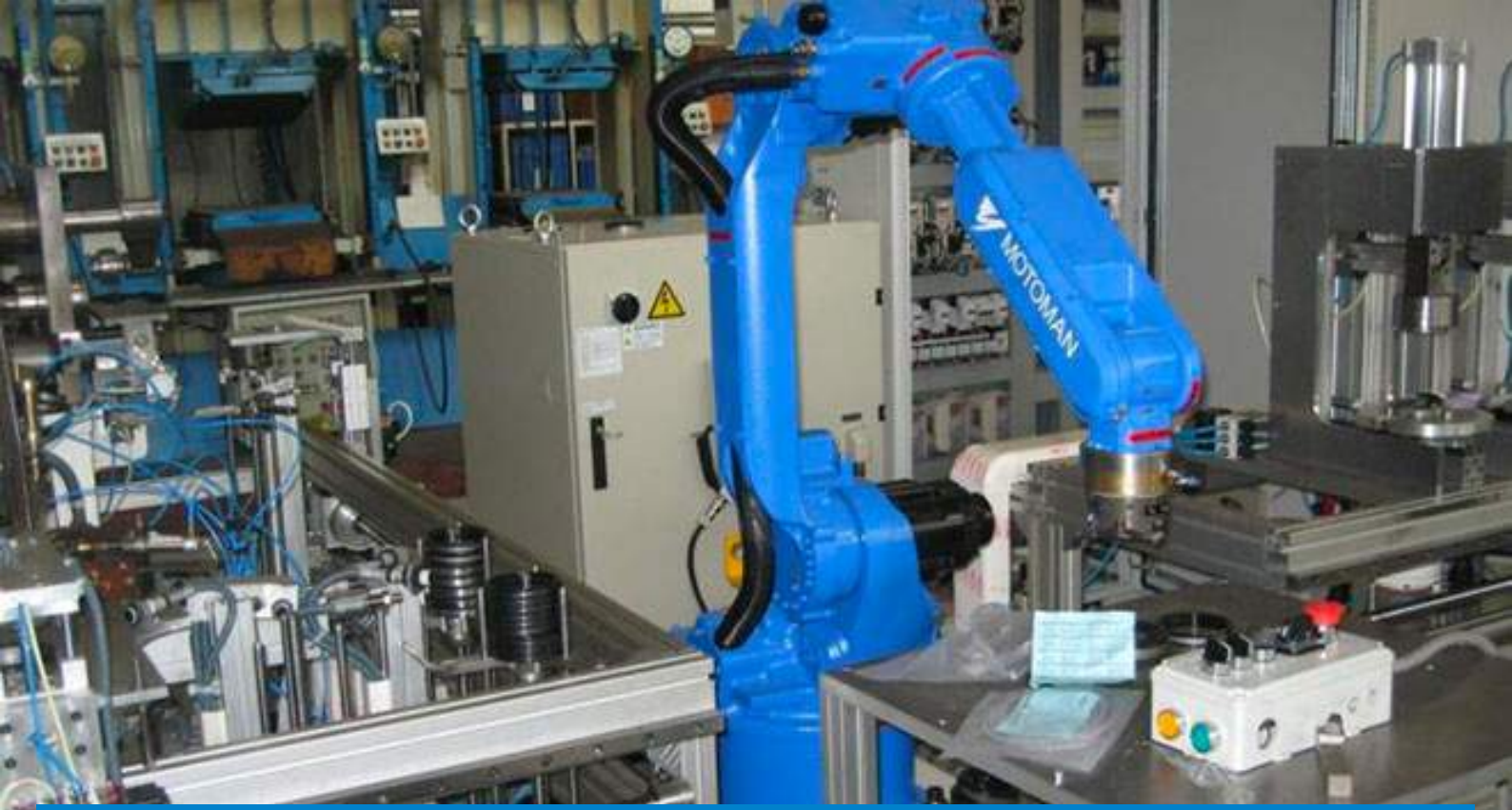

MAKİNE OTOMASYON ÇÖZÜMLERİ

- ARABA YIKAMA MAKİNELERİ
- BALATA PRES MAKİNELERİ
- GERİ DÖNÜŞÜM BALYALAMA MAKİNESİ
- PROFİL ÇEKME MAKİNELERİ
- HORTUM KESME
- NARENCİYE ELEKTRONİK BOYLAMA
- NARENCİYE KASA DOLUM
- DRENCHER PAKETLİ YIKAMA
- İNDÜKSİYON ISIL İŞLEM PROSESİ
- SHRINK MAKİNESİ
- STRAFOR KESME MAKİNESİ
- STRAFOR ENJEKSİYON MAKİNESİ
- STRAFOR BLOK MAKİNESİ
- STRAFOR ŞİŞİRME MAKİNESİ
- PEÇETE KESME MAKİNESİ
- KAĞIT BOBİN DİLİMLEME MAKİNESİ
- TAVAN VİNÇLERİ KOORDİNASYON OTOMASYONU
- ESTE MAKİNESİ
- MERMER SİLİM MAKİNESİ
- VOLÜMETRİK ŞİŞE DOLUM MAKİNESİ
- DİKEY PAKETLEME MAKİNELERİ
- YATAY PAKETLEME MAKİNELERİ
- FORMLANDIRMA VE BOY KESME MAKİNELERİ OTOMASYONU



ARITMA

İÇME SUYU ARITMA

- Kaskat Havalandırma Ünitesi
- Çöktürme Havuzları
- Kimyasal Dozajlama Ünitesi
- Kum Filtre Havuzları
- Klor Temas Tankları
- Geri Yıkama Üniteleri
- Çamur Yoğunlaştırma Tankları ve Belt Pres Filtreleri
- Ultrafiltrasyon Üniteleri
- Reverse Ozmoz Arıtma Sistemleri

TERFİ İSTASYON TESİS OTOMASYONLARI

ATIK SUYU ARITMA TESİSİ

- Kaba ve İnce Izgara Üniteleri
- Terfi Pompaları ve Havalandırma Havuz Sistemi
- Çamur Yoğunlaştırma ve Sıyırıcı Tankları
- Kimyasal Dozajlama ve Çamur Susuzlaştırma Üniteleri
- Belt Pres ve Geri Yıkama Su Sistemleri
- Deşarj ve Çıkış Yapısı Otomasyonu





MADEN

FELDSPAT İŞLEME TESİSİ

KURŞUN ÇİNKO İŞLEME TESİSLERİ

DEMİR ÇELİK TESİSİ

- Torpedo Refrakter Isıtma-Kurutma Ünitesi
- Haddehane Otomasyonu (Merdane Sistemleri, Sıcak-Soğuk Formlandırma Sistemleri, Boyutlandırma Sistemleri)

BORAKS İŞLEME TESİSİ

ÇİMENTO TESİSLERİ

- Kırma Eleme Tesisi
- Aktarma Sistemleri (Kovalı Elevatör, Havalı Bant, Helezonlar)
- Hammadde Homojenizasyon Ünitesi
- Farin Değirmen Sistemi
- Çimento Değirmen Sistemi
- Silo ve Depolama Sistemi
- Çimento Paketleme Sistemleri





İZLENEBİLİRLİK

- ENERJİ VERİ TOPLAMA VE İZLEME
- HAMMADDE TÜKETİM VE İZLEME PROGRAMLARI
- ÜRETİM İZLEME PROGRAMLARI
- PLANLI BAKIM İZLEME HİZMETLERİ

FABRİKA OTOMASYONU

- TOZ TUTMA TESİS OTOMASYONU
- BİRA MALT TESİS OTOMASYONU
- YEM TESİS OTOMASYONU
- YAPRAK TÜTÜN İŞLEME VE HARMANLAMA TESİS OTOMASYONU
- DÜZ CAM İŞLEME TESİS OTOMASYONU
- STRAFOR ÜRETİM TESİS OTOMASYONU
- NARENCİYE İŞLEME TESİSİ
- BEYAZ EŞYA MONTAJ HATTI



BİNA OTOMASYON ÇÖZÜMLERİ

- AYDINLATMA SİSTEMLERİ
- HAVALANDIRMA SİSTEMLERİ
- SOĞUTMA VE ISITMA SİSTEMLERİ
- GÜVENLİK SİSTEMLERİ



ÖRNEK PROJELERİMİZ



ÖRNEK PROJELERİMİZ

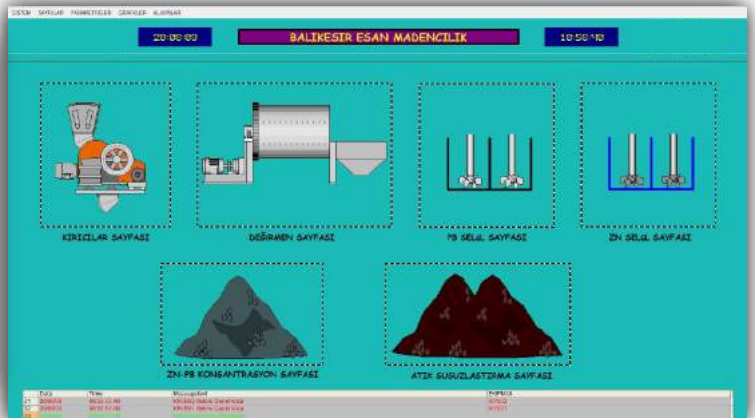
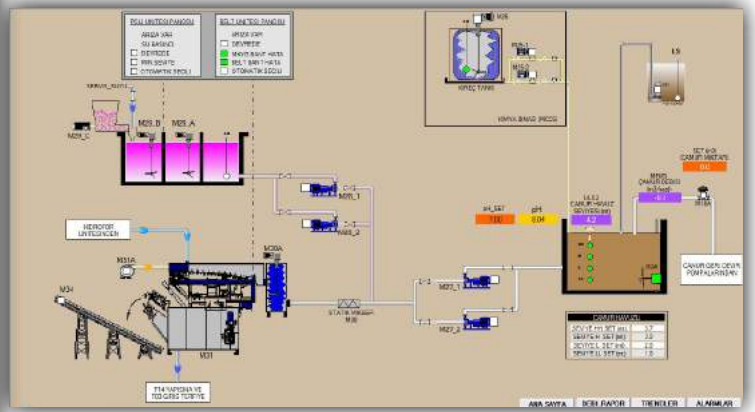
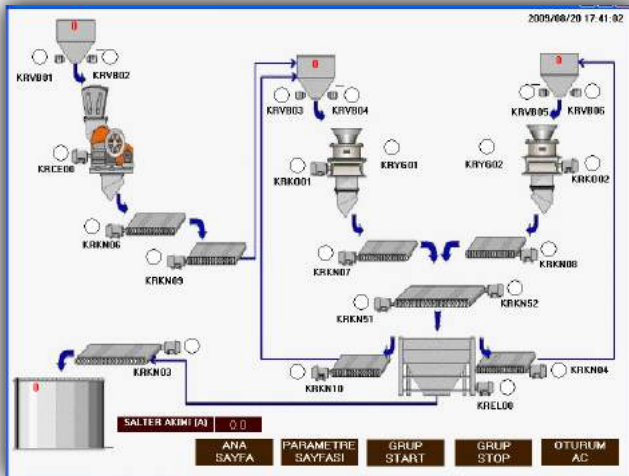
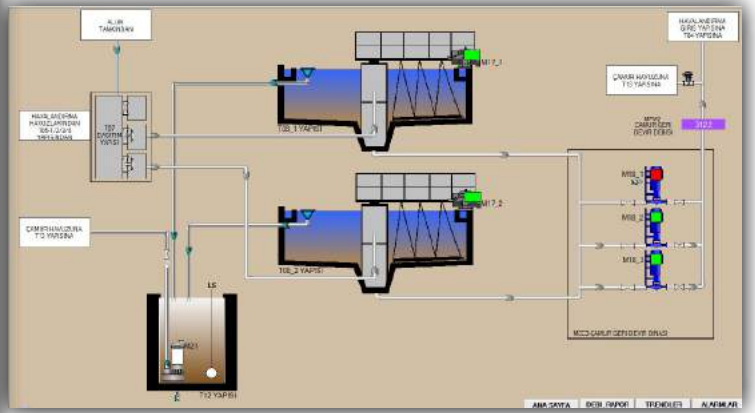
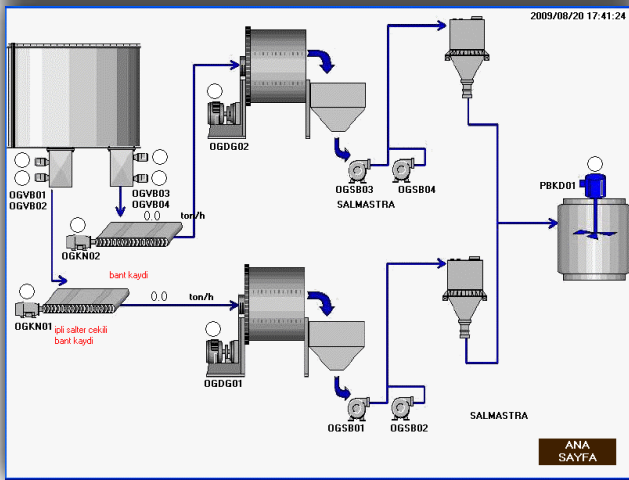
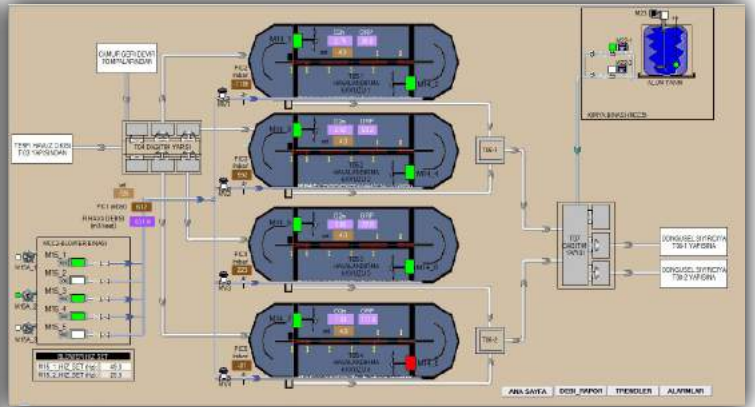
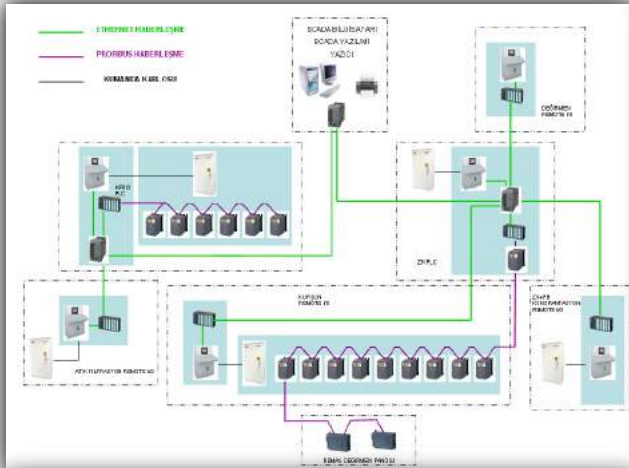

ÖRNEK PROJELERİMİZ

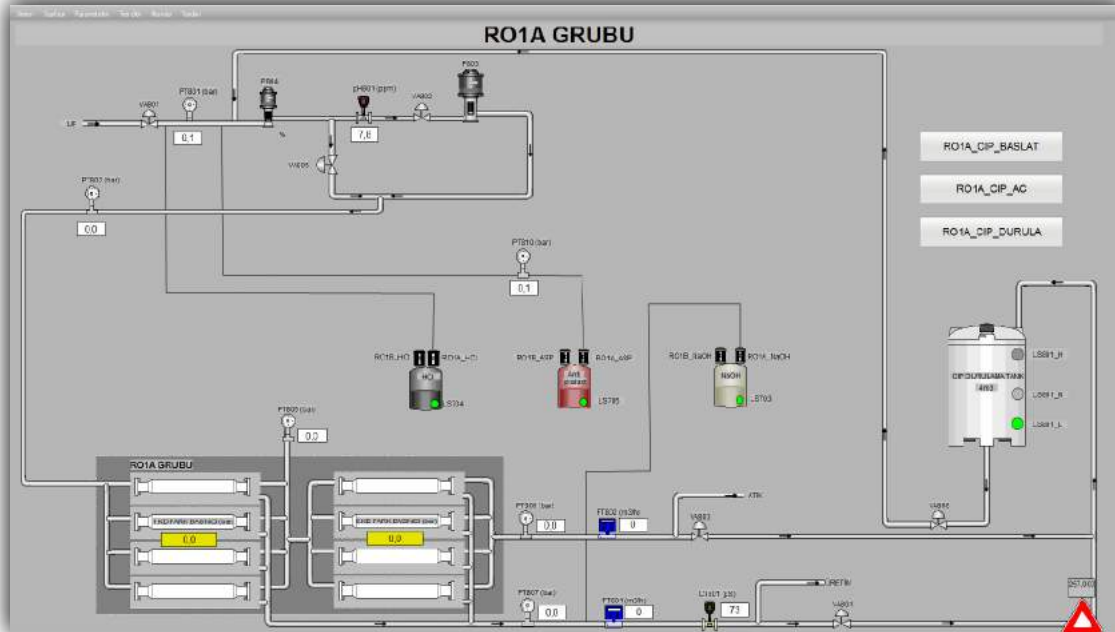
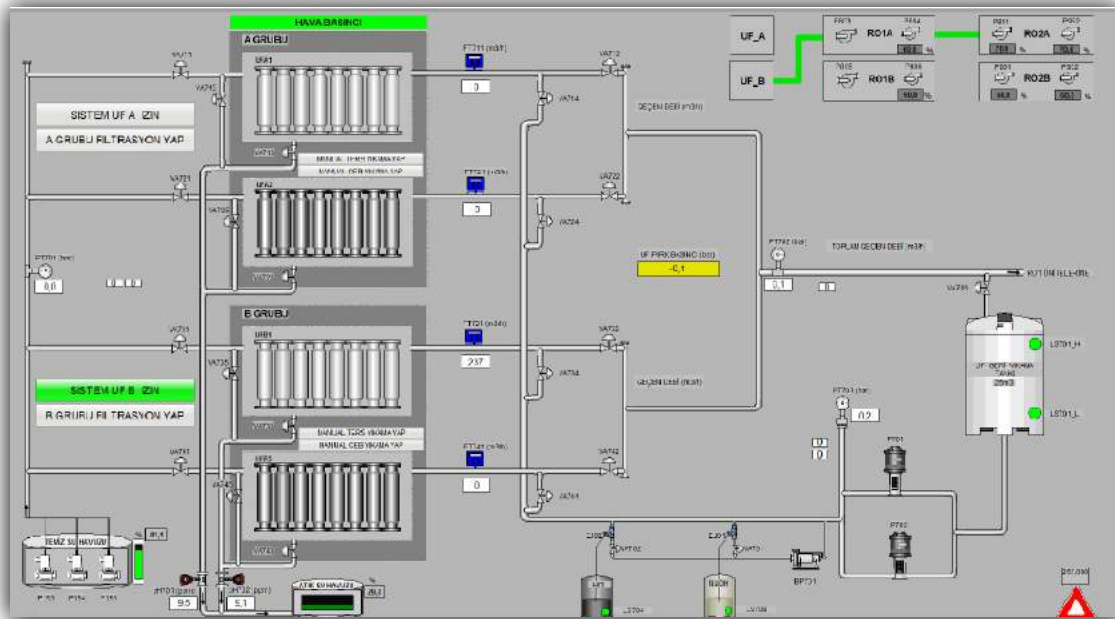
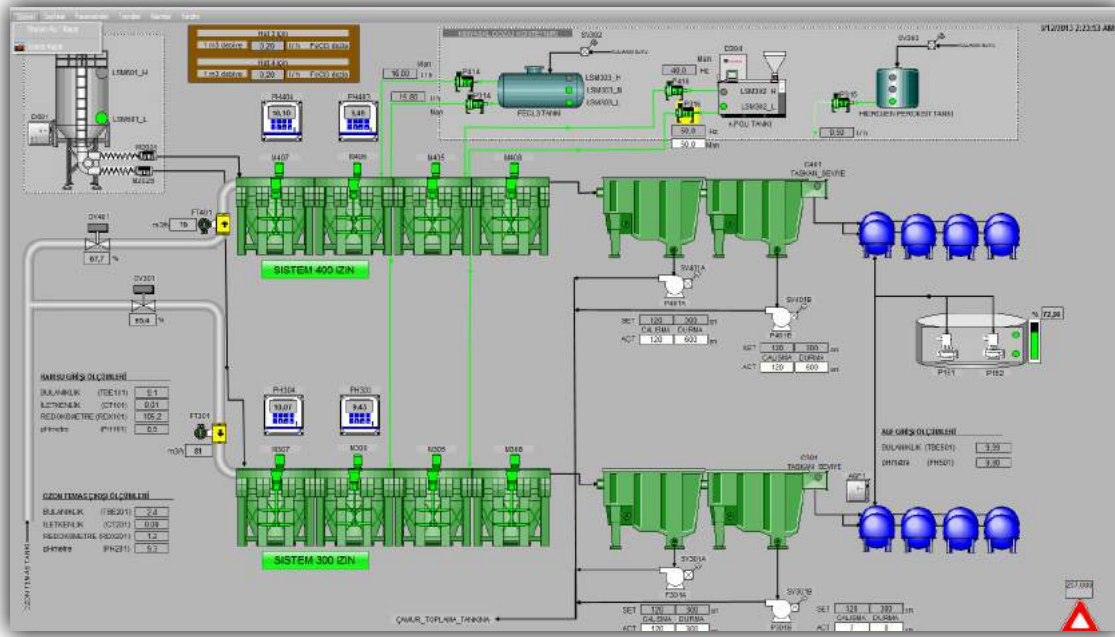

ÖRNEK PROJELERİMİZ

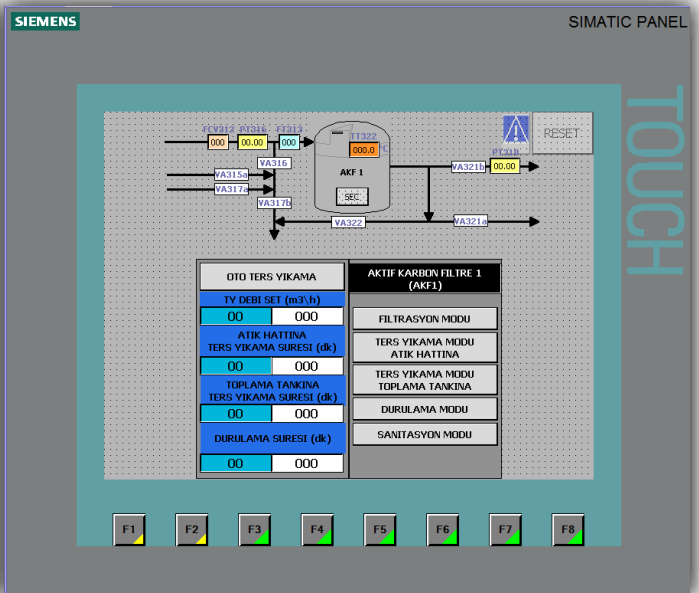
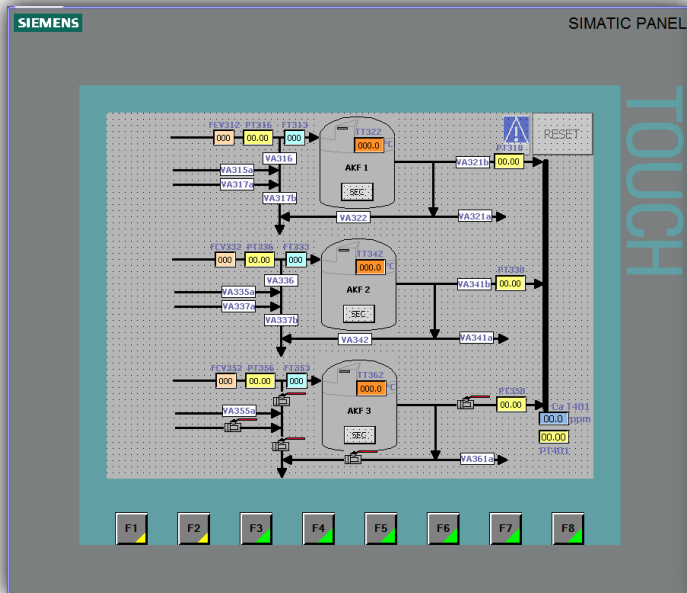
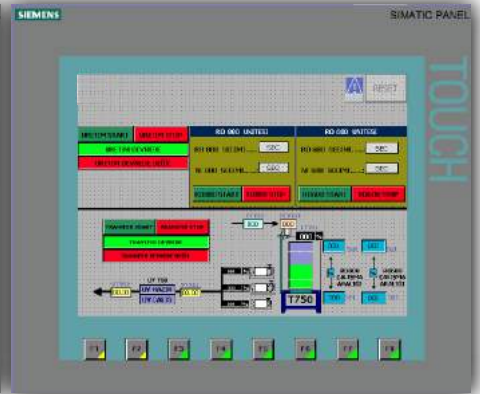
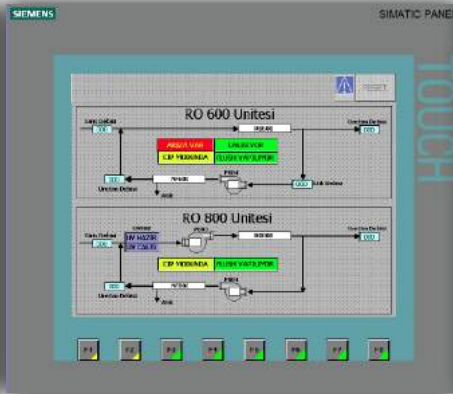
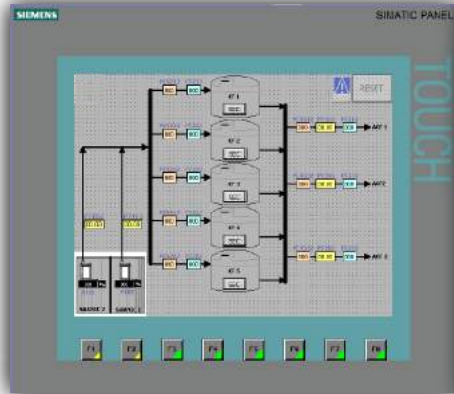
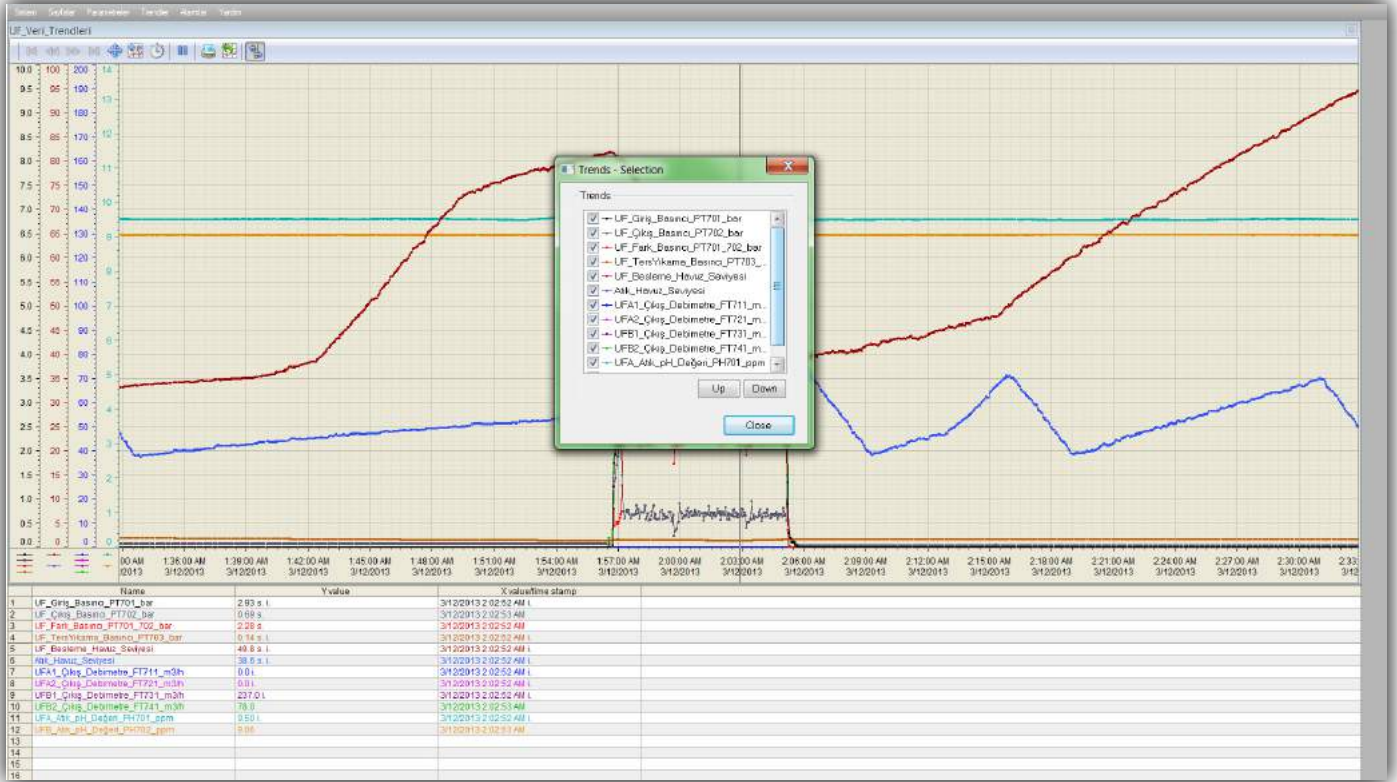

ABB

 **Allen-Bradley**

BANNER[®]

ARLENTUS
CONTROL

BECKHOFF

Beijer
ELECTRONICS

Danfoss

 **DELTA**

EXOR

 **GESSMANN**

LS

 **MITSUBISHI**
ELECTRIC

Movicon.next[™]

OMRON

Panasonic

 **PHOENIX**
CONTACT

INDUSTRIAL AUTOMATION SOFTWARE
progea 

Schneider
Electric

SIEMENS

 **Telemecanique**

TURCK

YASKAWA

WAGO

Weidmüller 